

25A AC Connector (EN,3-wire) Field Wiring Installation Guide

(For APSA)

Tools: Cross screwdriver, wire striper, solid wrench or monkey wrench .

Step 1. Verify the AC connector: Type is 2300531032 25A AC Male Connector (EN,3-wire) or 2300532032 25A AC Female Connector (EN,3-wire).

25A AC Male Connector(EN,3-wire)

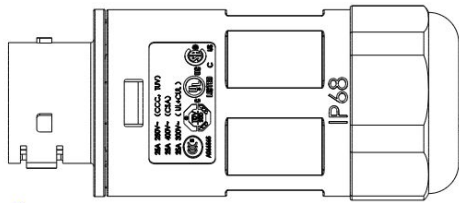

25A AC Female Connector(EN,3-wire)

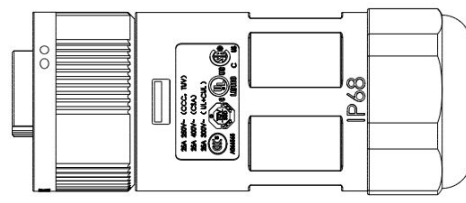

Step 2. Wire Stripping

Wire gauge : $3 \times 2.5\text{mm}^2 \sim 4\text{mm}^2$ (or 14AWG~12AWG)

Cable OD : 10mm~12mm

Wire stripping size (mm):Earth wire is supposed to be longer than Live wire and Neutral wire.

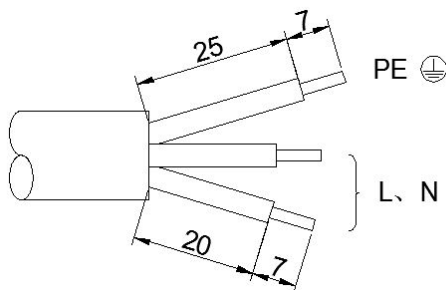

Step 3. Install the AC connectors

- a. Set the parts on the cable according to the order of 1→2→3→4.

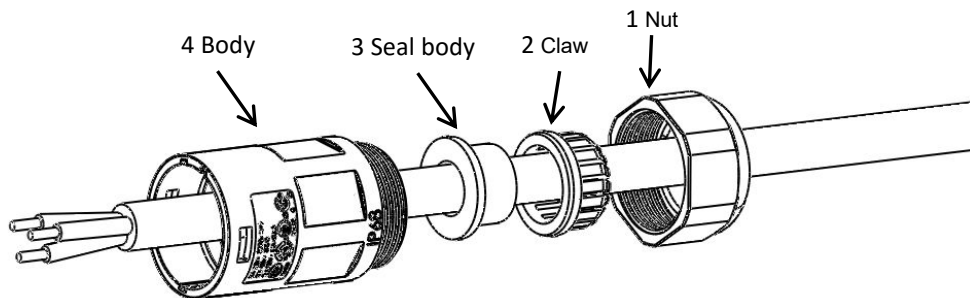

- b. Crimp wires: the plastic core of connector is printed, please wire according to the print, screw twisting torque $0.8 \pm 0.1 N \cdot m$.

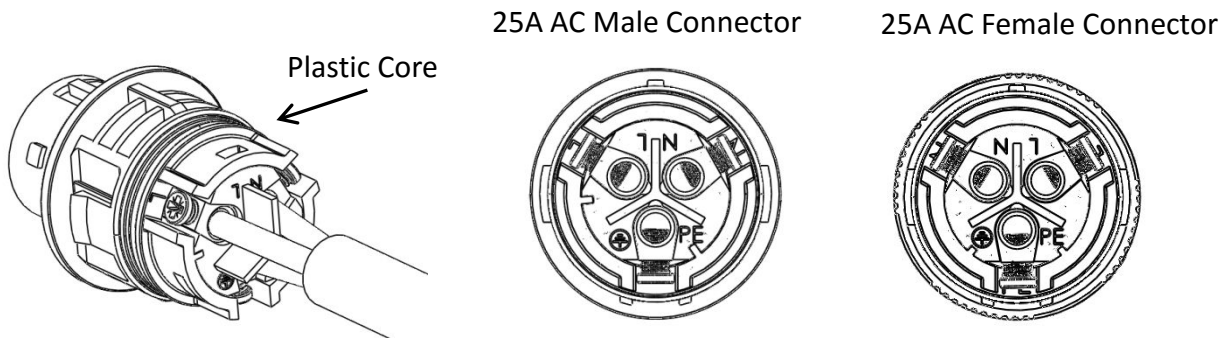

- c. Push Housing into Body until hear the the click sound.

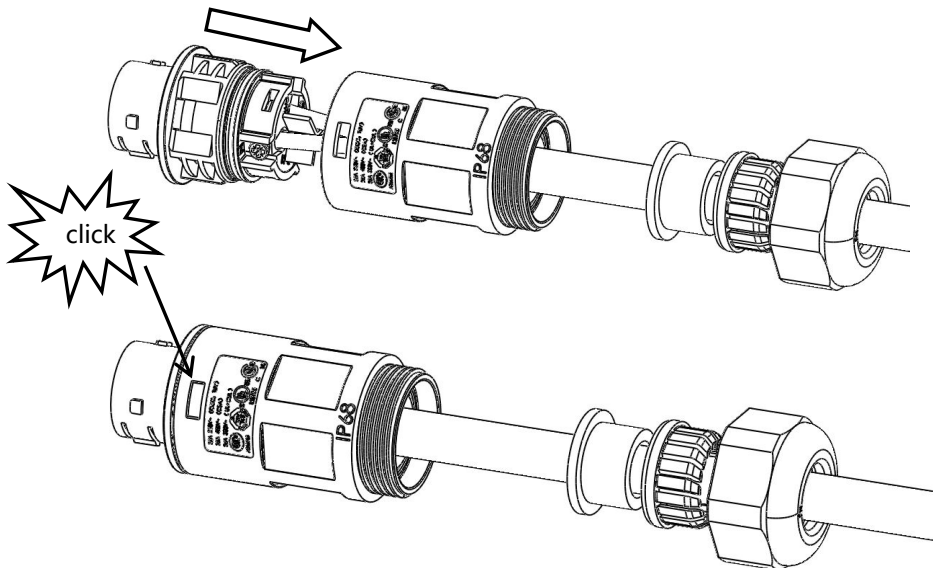

- d. Insert Seal and Clamp Finger into Body, then tighten the nut, torque $4.0 \pm 0.5 N \cdot m$

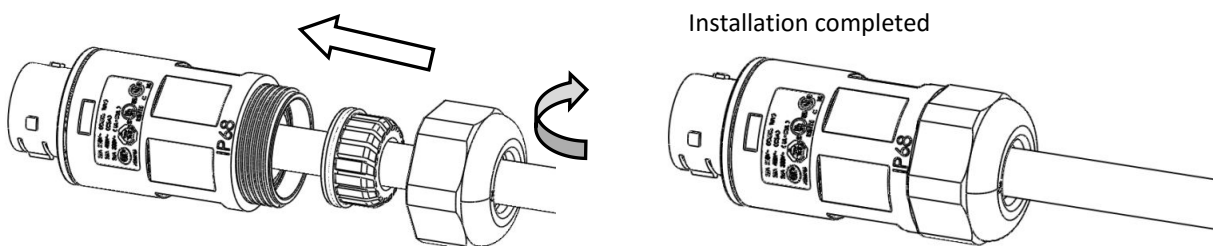

- e. Installation of cable end female connector is the same as male connector.